

# VALENTINES CANDY BOX

Made in Thailand exclusively for The Home Depot by Houseworks, Ltd.  
 2388 Pleasantdale Road, Atlanta, GA 30340 · 71189 · Thailand 0924

## Contents:

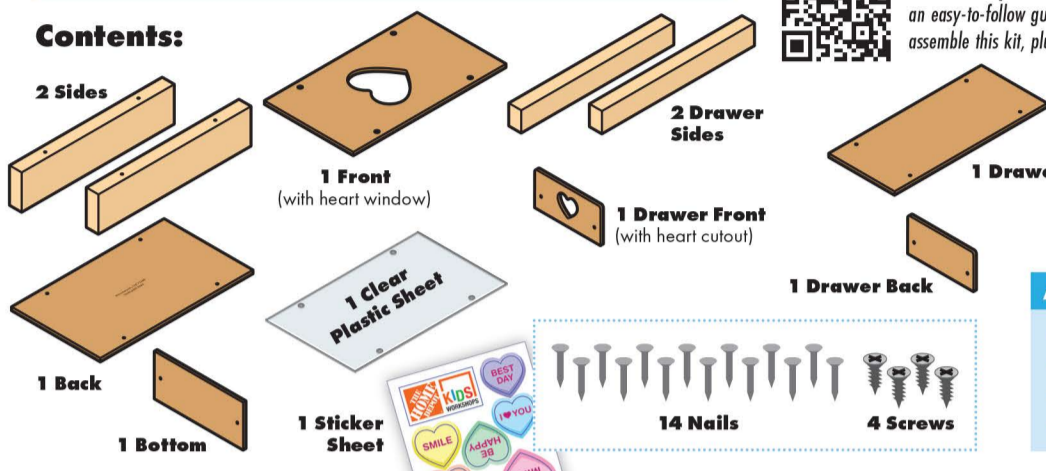

Scan with your camera or visit [homedepot.com/kids](http://homedepot.com/kids) for an easy-to-follow guide on how to assemble this kit, plus more fun videos.



Finished example.

## ALSO NEEDED:

- Fine Sandpaper
- Wood Glue
- Hammer
- #2 Phillips Screwdriver

## Assembly:

Start with sanding each wood piece to remove any rough edges. Remember to sand in the direction of the wood grain. Glue and nail the pieces together. Allow glue to completely dry.

**1 Step 1** — Identify the side pieces. The edges with holes are the top edges. Stand both **side pieces** upside down so that the holes face down. Glue the **back piece** on top. Ensure all corners are even. Nail them together with 4 **nails**.

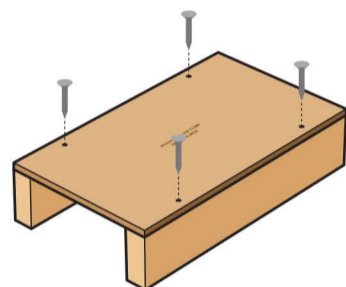
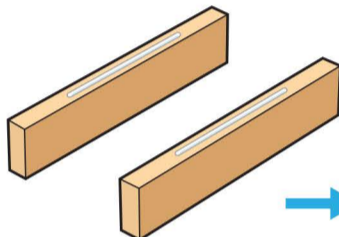
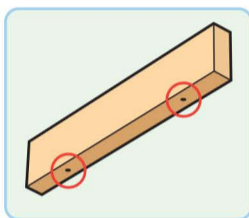

**2 Step 2** — Turn the project over. Remove the blue protective sheet from both sides of the **clear plastic sheet**. Place the **clear plastic sheet** and the **front piece** on top of the project, aligning all corners and holes. Attach them together with 4 **screws** using a #2 Phillips screwdriver.

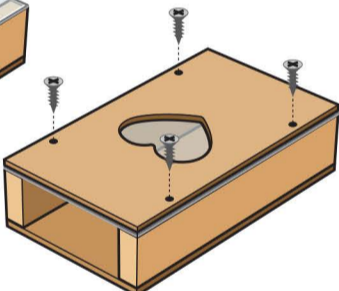

**3 Step 3** — Stand the project up with the heart window upside down. Glue the **bottom piece** on top, ensuring all edges are even. Nail them together with 2 **nails** to form a **box**. Set the **box** aside for now.

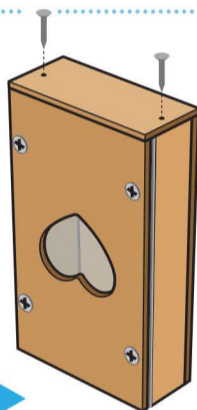
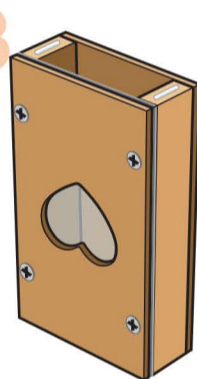

**4 Step 4** — Stand both **drawer side pieces** up on their narrow edges. Glue the **drawer bottom piece** on top. Ensure all corners are even. Nail them together with 4 **nails**.

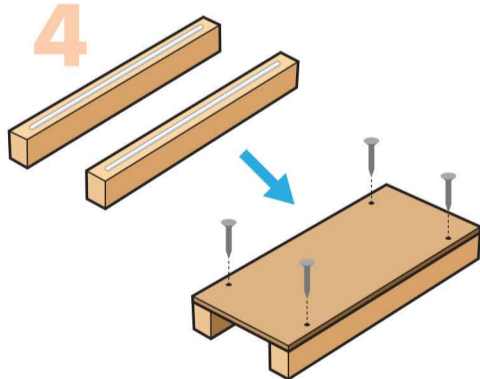

**5 Step 5** — Stand the project up. Apply glue to the top edge of the **drawer side pieces**. Place the **drawer back piece** on top, aligning the square corners with the bottom edge. The rounded corners will overhang. Ensure the side and bottom edges are even. Nail them together with 2 **nails**. Turn the project over. Repeat on other side with the **drawer front piece**, forming the **drawer**.

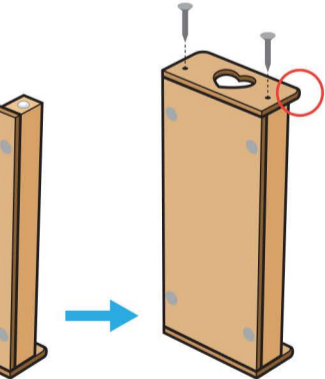
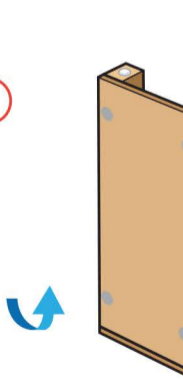
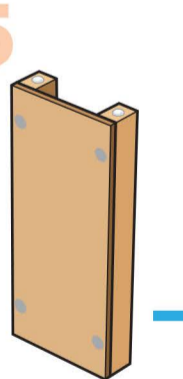

**6 Step 6** — Insert the **drawer** into the **box**.

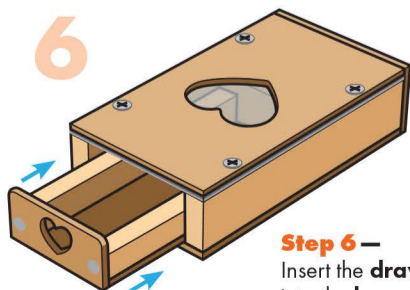

**Attention:** When painting, **don't paint the clear plastic sheet; wipe off any spills promptly.** Let it dry completely.

**7 Step 7** — Add the **stickers** as shown.



(Ver el dorso para instrucciones en español.)

TSCA TITLE VI Compliant

**At Home:** Fill the Valentines Candy Box with individually wrapped candies.